



Actuator Manual

REV-B

Force up to 1.2 ton (2500 lbs)

Speed up to 5 cm/s (2 in/s)

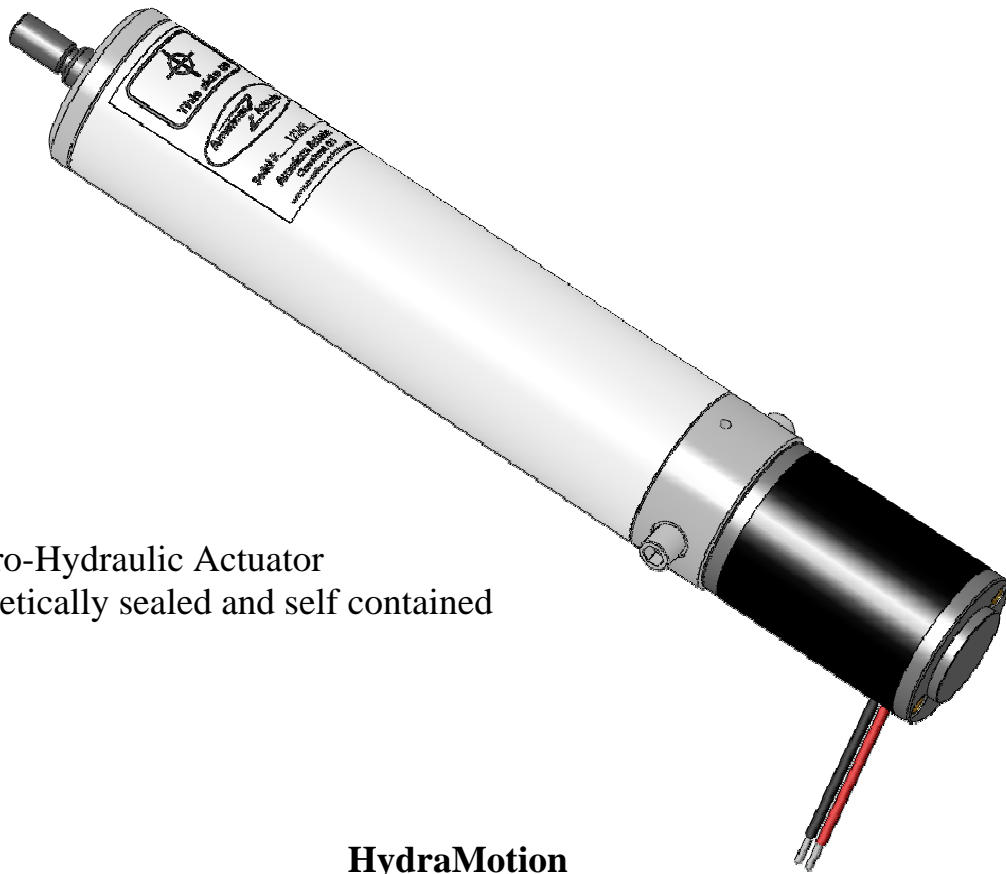

Electro-Hydraulic Actuator
Hermetically sealed and self contained

HydraMotion
4540 West 160th Street
Cleveland, Ohio 44135
hydramotion.net
216-362-7725 fax 216-362-0799

TECHNICAL DATA

- Aluminum exterior, except for the motor jacket and rod.
- Permanent magnet electric motors, 12V, 24V, 90V.
- Ambient operating temperature, 20°F to 110°F.
- Custom strokes up to 48 inches.
- Rod is noncorrosive Nitrotec steel

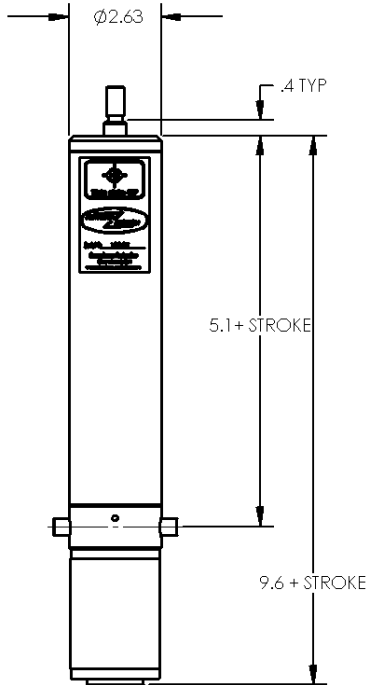

Actuator 125-35

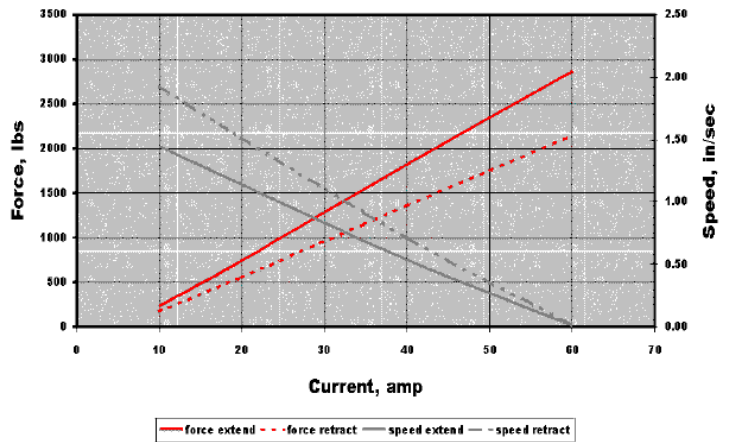

S3 (5 min) Duty Cycle

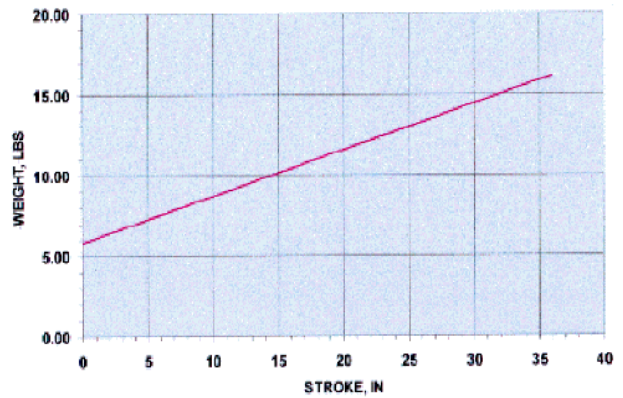
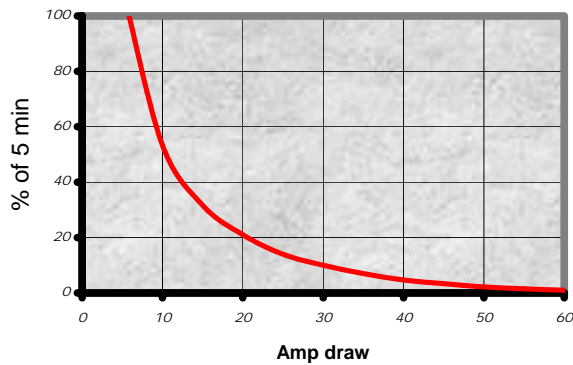



Performance data is for reference only

Installation

Bleed the actuator prior to installation by holding the unit horizontally with the sticker facing upward and fully extend and retract the rod at least 4 times.

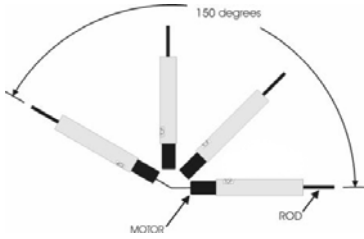
Actuators can be configured in three different ways depending on your application requirements. The serial number sticker shows you the Motion Range of the Actuator as follows.

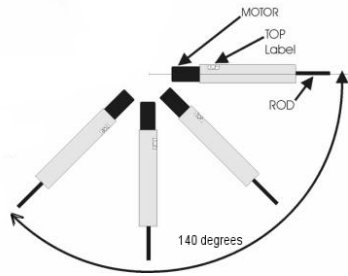
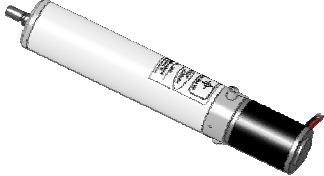
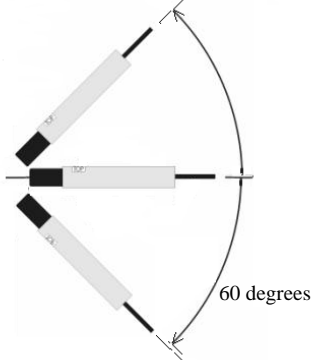
		MOTION RANGE
Standard		
Inverted		
Sideways		

Note!!

Do Not operate the Actuator outside its designated Motion Range. Reduced performance or pump failure can occur.